

Installation Instructions

LED Canopy

RCN Series

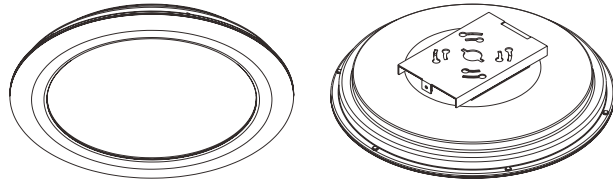

WARNING Risk of Fire and Electric Shock.

The luminaire must be installed by a qualified electrician in accordance with applicable federal, state, and local laws and codes. Installation requires knowledge of luminaire electrical systems and installer should be familiar with the operation of this product. If not qualified, do not attempt installation; contact a qualified electrician. Manufacturer assumes no responsibility for the improper installation of this luminaire. When installing the fixture, drilling may damage luminaire wiring and electrical parts. Check for wiring and components in enclosure before drilling. Turn OFF power before installation or attempting any maintenance.

To prevent wiring damage or abrasion, do not expose wiring to edges of sheet metal or other sharp objects. When installing this kit, drilling may damage luminaire wiring and electrical parts. Check for wiring and components in enclosure before drilling.



WARNING Risk of Burn.

Disconnect power and allow fixture to cool before handling or servicing.



WARNING Risk of Personal Injury.

Wear gloves or proper handling protection to prevent cuts or abrasions when handling and maintaining this product. This equipment may have sharp edges. To reduce the risk of death, personal injury or property damage from fire, electric shock, falling parts, cuts/abrasions, and other hazards read all warning and instructions included with and on the fixture box and all fixture labels.

Avoid direct eye exposure to the light source while it is on.

NOTICE

- Green ground screw provided in proper location. Do not relocate.
- Minimum 90°C supply conductors.
- Suitable for Wet location.
- Specifications and dimensions subject to change without notice.



Contact manufacturer with any questions or concerns regarding installation of this luminaire.

Alphalite

Installation Instructions

LED Canopy

Surface Mount Installation steps:

1. Remove the locking screw to separate the top half of the surface bracket.
2. Mount the bracket to the desired surface using the appropriate hardware (not provided).
3. Hang the fixture on the mounted bracket.
4. Feed the supply cable from the fixture through the conduit and wire in the junction box according to wiring diagram.
5. Raise the fixture to secure with the locking screw removed step 1.
6. Secure the bracket with the locking screw.

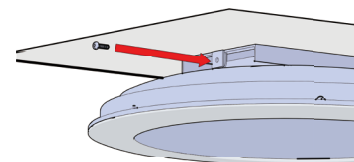
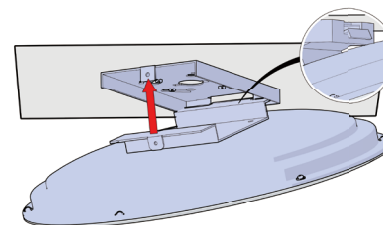
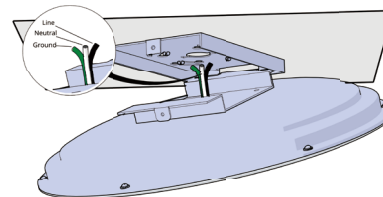
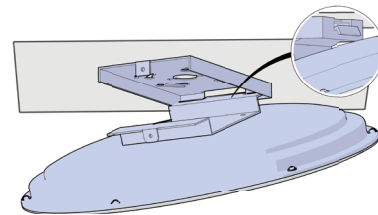
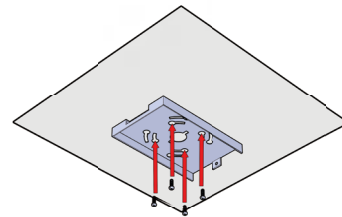
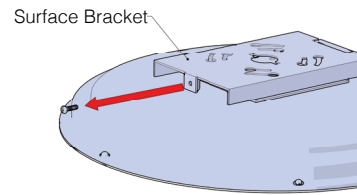

Wiring Diagram

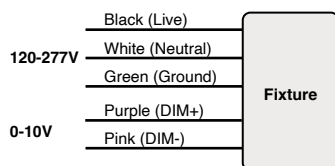

CAUTION

1. Avoid direct eye exposure to the light source while it is on.
2. Account for small parts and destroy packing material, as these may be hazardous to children
3. Disconnect power and allow fixture to cool before changing bulb or handing fixture.

Alphalite

Installation Instructions

LED Canopy

Pendant Mount Installation steps:

1. Remove the locking screw to separate the top half of the mounting bracket.
2. Mount the top bracket to a 3/4" trade size conduit as shown and secure with two locking nuts (not provided).
3. Hang the fixture on the mounted bracket.
4. Feed the supply cable from the fixture through the conduit and wire in the junction box according to the wiring diagram.
5. Raise the fixture to secure with the locking screw removed in step 1.
6. Secure the bracket with the locking screw.

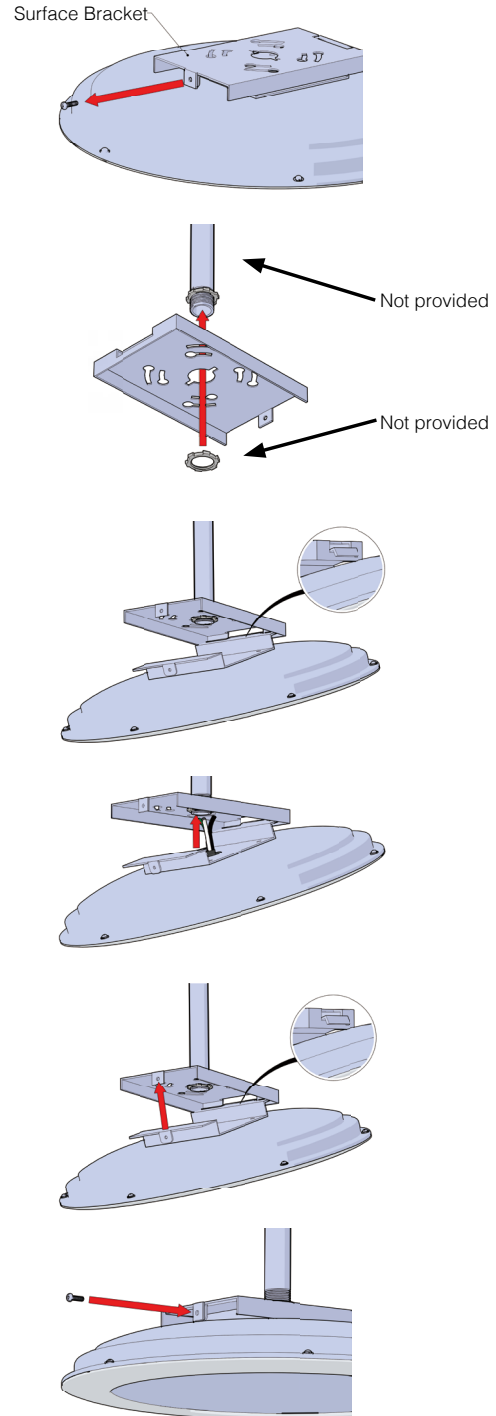

CAUTION

1. Avoid direct eye exposure to the light source while it is on.
2. Account for small parts and destroy packing material, as these may be hazardous to children
3. Disconnect power and allow fixture to cool before changing bulb or handing fixture.

Alphalite